

ZERO 12.7mm HIGH FLAT THRESHOLDS

Sizes: 914mm (3 ft), 1219mm (4 ft), 1829mm (6 ft), 2134mm (7 ft), 3048mm (10 ft). Other sizes available to order, maximum 3048mm.
 Finishes: A=mill aluminium, B=self colour brass (aka US bronze), D=dark bronze anodised, E=epoxy, STST=stainless steel, V3=full body strength where indicated.
 Availability: usually ex-stock except items marked with an asterisk, which are to special order (2-3 weeks) depending on quantity.

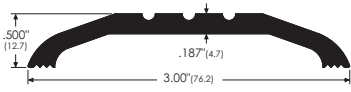

653A

76mm wide x 12.7mm high utility plain grooved threshold
 653A Aluminium, mill finish

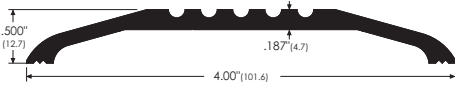

654A, 654B

102mm wide x 12.7mm high utility plain grooved threshold
 654A Aluminium, mill finish
 654B Brass, self colour

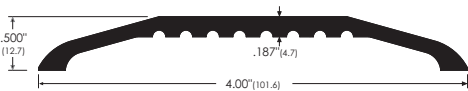

164A

102mm wide x 12.7mm high utility smooth top plain threshold (no grooves)
 164A Aluminium, mill finish

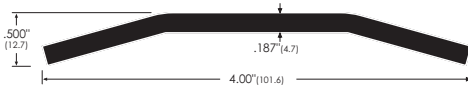

164STST

102mm wide x 12.7mm high utility smooth top plain threshold (no grooves). "E" abrasive surface is suggested for public access areas
 164STST Stainless steel

For more stainless thresholds please see page 33

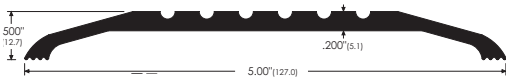

655A, 655B

127mm wide x 12.7mm high utility plain grooved threshold
 655A Aluminium, mill finish
 655B* Brass, self colour



8655A

127mm wide x 12.7mm high utility plain grooved threshold (light duty)
 8655A* Aluminium, mill finish



656A, 656B

152mm wide x 12.7mm high utility plain grooved threshold (undrilled)
 656A Aluminium, mill finish
 656B* Brass, self colour

For under door seals to be used in conjunction with these thresholds please refer to pages 34-37

ZERO 12.7mm HIGH FLAT THRESHOLDS

Sizes: 914mm (3 ft), 1219mm (4 ft), 1829mm (6 ft), 2134mm (7 ft), 3048mm (10 ft). Other sizes available to order, maximum 3048mm.
 Finishes: A=mill aluminium, B=self colour brass (aka US bronze), D=dark bronze anodised, E=epoxy, STST=stainless steel, V3=full body strength where indicated.
 Availability: usually ex-stock except items marked with an asterisk, which are to special order (2-3 weeks) depending on quantity.



657A

178mm wide x 12.7mm high utility plain grooved threshold for use with floorsprings in new applications (undrilled)
 657A Aluminium, mill finish



6570A

178mm wide x 12.7mm high utility plain grooved threshold for use with floorsprings (undrilled)
 6570A Aluminium, mill finish

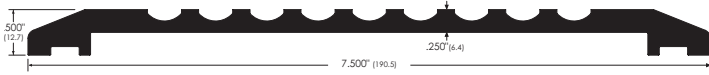

6575A

190mm wide x 12.7mm high utility plain grooved threshold for use with floorsprings in existing applications (undrilled)
 6575A Aluminium, mill finish

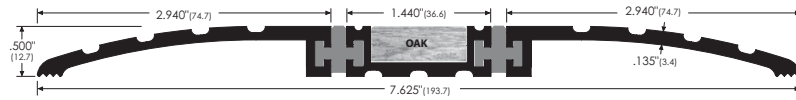

726A

194mm wide x 12.7mm high thermal break threshold with PVC breaks and oak insert
 726A* Aluminium, mill finish

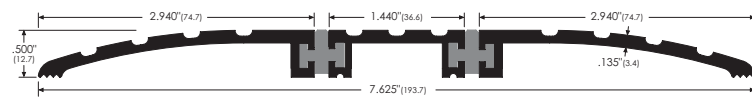

8726A

194mm wide x 12.7mm high thermal break threshold with PVC breaks
 8726A* Aluminium, mill finish

See pages 24-25 for more thermal break thresholds.

WHEELCHAIR SHOWER THRESHOLDS

Designed for use when a shower must be accessible to a wheelchair. The neoprene gasket will keep water in while allowing the wheel to pass over easily.

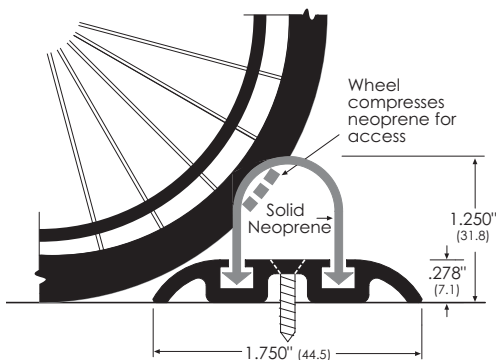

8452A

44mm wide x 7mm high wheelchair accessible shower threshold. The solid neoprene gasket is 32mm high and will retain water, while allowing wheelchair users to pass over it easily.
 8452A Aluminium, mill finish